

Data Sheet

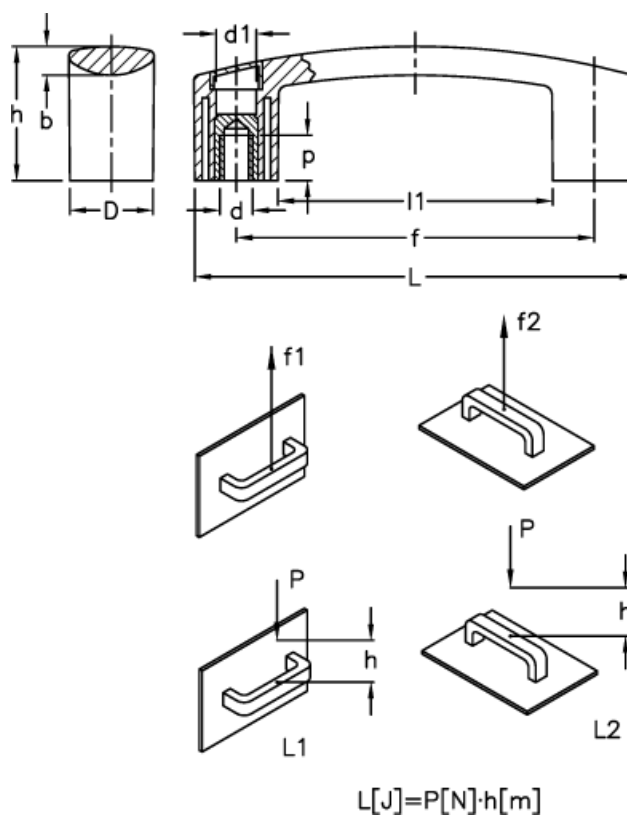

Article number: 23052603215
Description: E+G Bridge handle
EBP.180-B M8-C5

Measures



b	$= 9.5$	L	$= 178.0$
D	$= 28.0$	$l1$	$= 122.0$
$d1$	$= 13.5$	$L1 (J)$	$= 12$
$d 6H$	$= M8$	$L2 (J)$	$= 5$
f	$= 150 +/-1$	p	$= 13$
$F1 (N)$	$= 2700$		
$F2 (N)$	$= 1500$		
h	$= 45$		